

Use wire diameter: 24-10AWG

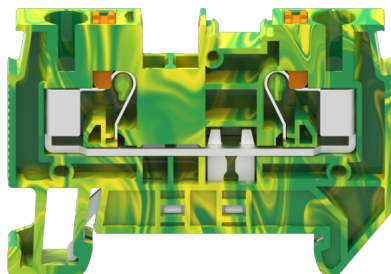

The catalog is for reference only. The actual specifications are subject to the product engineering drawings. version 1.0

UL (1059)

| Use Group | B | C | D |
|------------------|---|---------|---|
| Wire Range [AWG] | | 24 ~ 10 | |

IEC (60947-7-2)

| | |
|--|---------|
| Soild [mm ²] | 0.2-6.0 |
| Flexible [mm ²] | 0.2-4.0 |
| Flexible with ferrule [mm ²] | 0.2-4.0 |
| Overvoltage Category | III |
| Contamination Class | 3 |
| Impulse withstand voltage [KV] | 8 |

Material

| | |
|------------------------------|--------------|
| Insulation Material | PA66 |
| Flame retardant rating | UL94V-0 |
| Conductor Material | Copper alloy |
| Plating of conductor surface | Sn plated |

Other Date

| | |
|------------------------------|---------------|
| Length/Height/Thickness [mm] | 55.9/35.2/6.2 |
| Stripping Length [mm] | 10-12 |

Dimensions

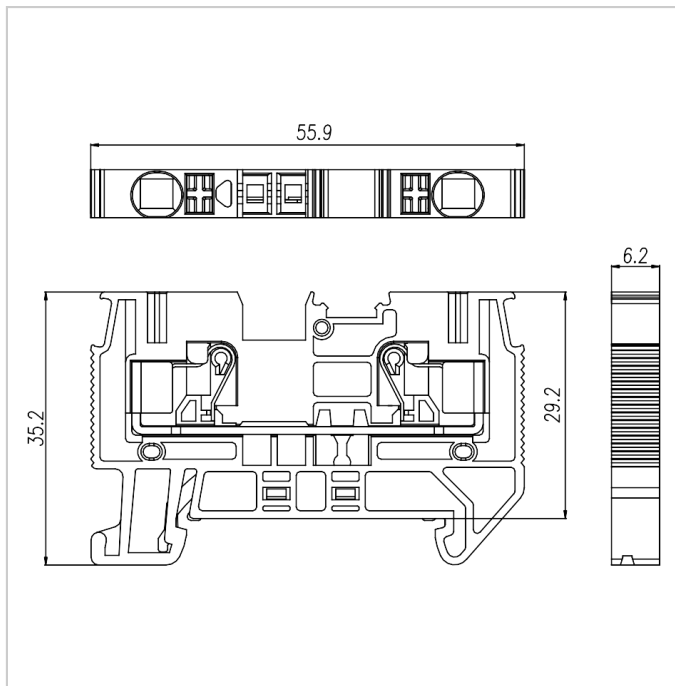

Accessories

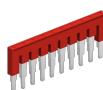

DUV4-102

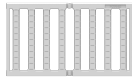

FUVA4-XX

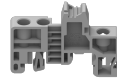

MUV4-10



PUV4-80



EB-35

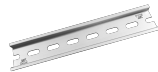

EW-35

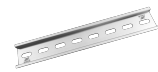

DGL2-35x7.5A



DGL2-35x7.5B

DGL2-35x7.5C

DGL2-35x7.5D