

Use wire diameter: 24-10AWG

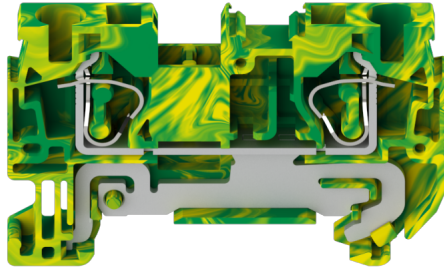

The catalog is for reference only. The actual specifications are subject to the product engineering drawings. version 1.0

UL (1059)

Wire Range [AWG]	24 ~ 10
------------------	---------

IEC (60947-7-2)

Soild [mm ²]	0.2-6.0
Flexible [mm ²]	0.2-4.0
Flexible with ferrule [mm ²]	0.2-4.0
Overvoltage Category	III
Contamination Class	3
Impulse withstand voltage [KV]	8

Material

Insulation Material	PA66
---------------------	------

Flame retardant rating	UL94V-0
Conductor Material	Copper alloy
Plating of conductor surface	Sn plated

Other Date

Length/Height/Thickness [mm]	56.0/35.4/6.2
Stripping Length [mm]	8-10

Dimensions

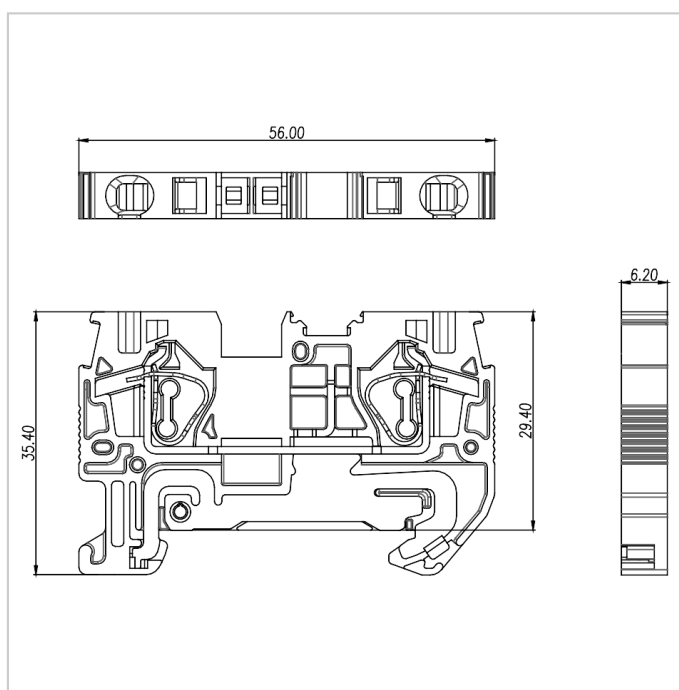

Accessories



DUV4-102

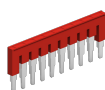

FUVA4-XX



MUV4-10

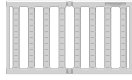

PUV4-80

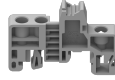

EB-35



EW-35



DGL2-35x7.5A

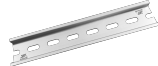

DGL2-35x7.5B

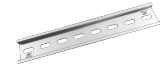

DGL2-35x7.5C



DGL2-35x7.5D