

Use wire diameter: 26-12AWG

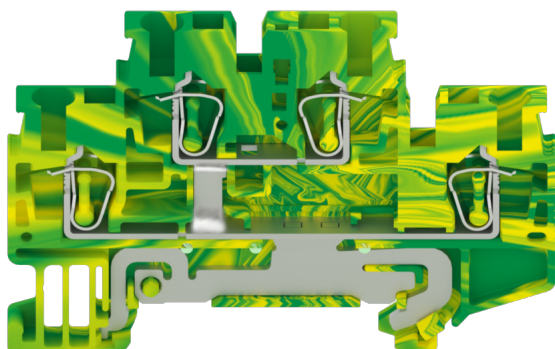

The catalog is for reference only. The actual specifications are subject to the product engineering drawings. version 1.0

UL ( 1059 )

|                  |         |
|------------------|---------|
| Wire Range [AWG] | 26 ~ 12 |
|------------------|---------|

IEC ( 60947-7-2 )

|  |         |
|--|---------|
| Soild [mm <sup>2</sup> ]                 | 0.2-4.0 |
| Flexible [mm <sup>2</sup> ]              | 0.2-2.5 |
| Flexible with ferrule [mm <sup>2</sup> ] | 0.2-2.5 |
| Overvoltage Category                     | III     |
| Contamination Class                      | 3       |
| Impulse withstand voltage [KV]           | 6       |

Material

|                     |      |
|---------------------|------|
| Insulation Material | PA66 |
|---------------------|------|

|                              |              |
|------------------------------|--------------|
| Flame retardant rating       | UL94V-0      |
| Conductor Material           | Copper alloy |
| Plating of conductor surface | Sn plated    |

Other Date

|                              |               |
|------------------------------|---------------|
| Length/Height/Thickness [mm] | 67.7/46.0/5.2 |
| Stripping Length [mm]        | 8-10          |

Dimensions

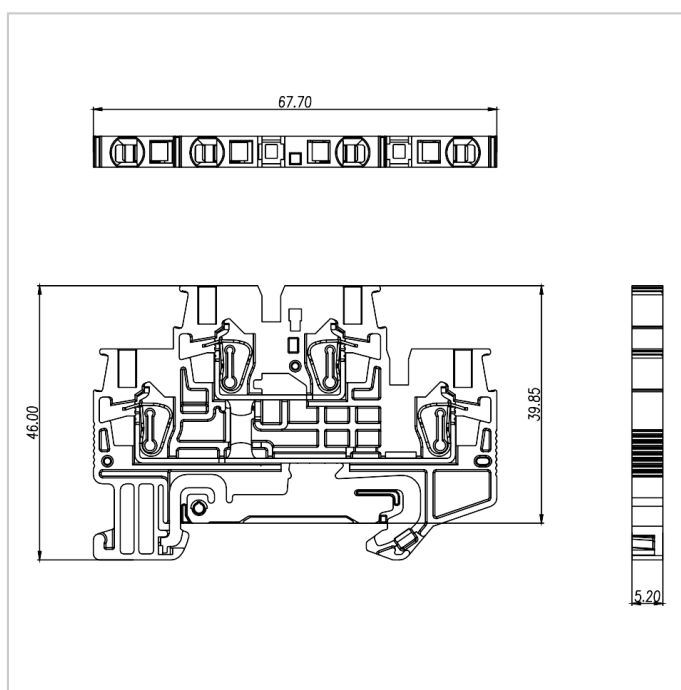

Accessories

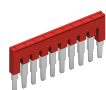

FUVA2.5-XX



DUS2.5-202

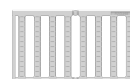

PUV2.5-96

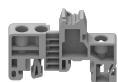

EB-35



EW-35



DGL2-35x7.5A

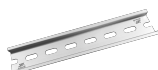

DGL2-35x7.5B

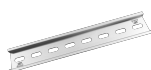

DGL2-35x7.5C



DGL2-35x7.5D