

# M87-A\*\*-ST0-M01-BQ1

7/8" Circular Connector

Download Date:2026-07-07

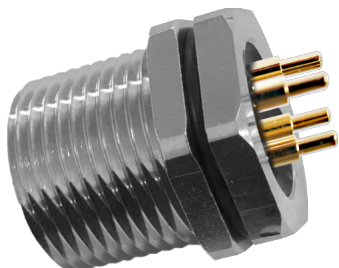

7/8" Male Panel Mount, PCB Type, Front Fastened



The catalog is for reference only. The actual specifications are subject to the product engineering drawings. version 1.0

## Connector Series: 7/8"

Gender	Male
Coding	A
Locking Type	Fix Screw
Mounting Type	Front Fastened
Part No	M87-A**-ST0-M01-BQ1

## Technical Data

Ambient Temperatur	-25°C~+85°C
Insulation Resistance	≥100MΩ
Contact Resistance	≤5mΩ
IP Class	IP67

Mating Endurance	>100 Mating Cycles
------------------	--------------------

## Material Data

Connector Carriers	PA
Connector Contacts	Copper Alloy With Gold Plated
Connector Nut/Screw	Copper Alloy With Nickel Plated
Shielding	Unshielded
Seal/O-Ring	FKM

## Electrical Data & Mechanical Date

Contacts Pin [Pins]	2	3	4	5
Rated Current [A]	13	13	13	8
Voltage AC/DC [V]	300/300			
Contacts Termination	PCB Version			

## Dimensions

## PCB hole diagram

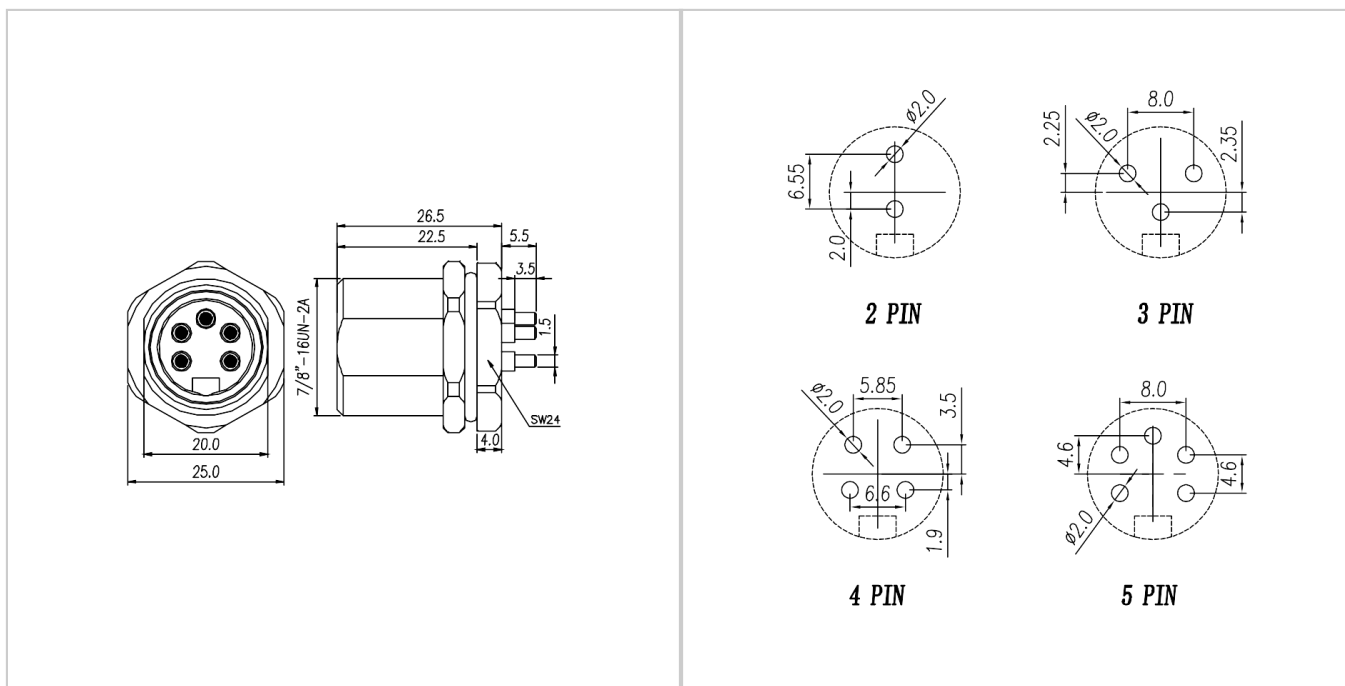

## Accessories



M87-A\*\*-ST0-F02-BC\*-XXX



M87-A\*\*-RA0-F02-BC\*-XXX