

Rated current: 35A

Rated voltage: 600V

Use wire diameter: 24-8AWG

spacing:7.62mm

The catalog is for reference only. The actual specifications are subject to the product engineering drawings. version 1.0

### UL/CUL

Use Group	B	C	D
Rate Voltage [V]	600	600	-
Rated Current [A]	35	35	-
Wire Range [AWG]	24-8		
Dielectric Voltage-Withstand	2.2KV		

### IEC

Overvoltage Category	III	III	II
Contamination Class	3	2	2
Rated Voltage [V]	1000	1000	1000
Rated Current [A]	41	41	41

Impulse withstand voltage [KV]	8	8	6
Conductor cross section [mm <sup>2</sup> ]	0.2-6.0		

### Material

Insulation Material	PA66
Flame retardant rating	UL94V-0
Conductor Material	Copper alloy
Plating of conductor surface	Sn plated

### Other Date

Pitch/Poles [mm]/[P]	7.62/2-12
Stripping Length [mm]	14-15
Screw/Torque(Max)[N.m]	-
Operating temperature [°C]	-40 ~ +105

### Dimensions

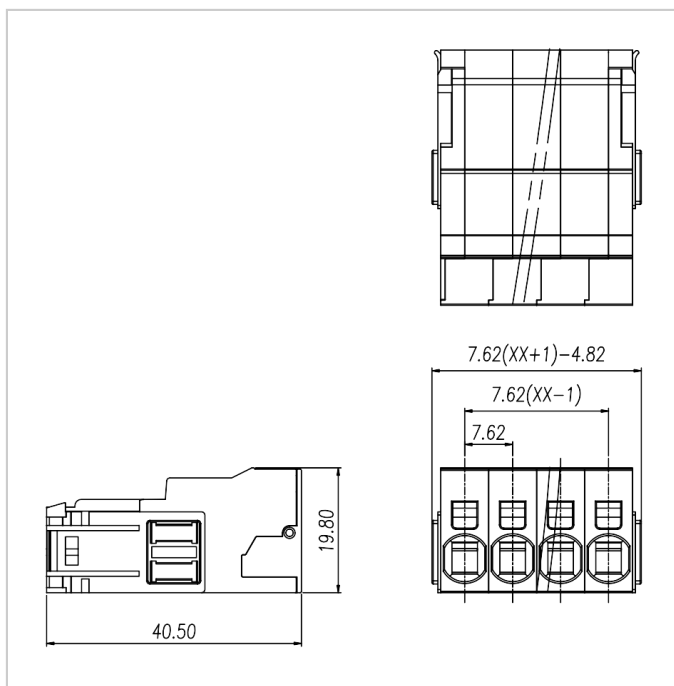

## Accessories



WJ3EDGK-7.62



WJ3EDGKV-7.62



WJ3EDGKH-7.62



WJ3EDGB-7.62



WJ3EDGA-7.62