

Rated current: 8A
 Rated voltage: 300V
 Use wire diameter: 28-16AWG
 spacing:3.5mm

The catalog is for reference only. The actual specifications are subject to the product engineering drawings. version 1.0

UL/CUL

Use Group	B	C	D
Rate Voltage [V]	300	-	300
Rated Current [A]	8	-	8
Wire Range [AWG]	28-16		
Dielectric Voltage-Withstand	1.6KV		

IEC

Overvoltage Category	III	III	II
Contamination Class	3	2	2
Rated Voltage [V]	160	160	320
Rated Current [A]	8	8	8

Impulse withstand voltage [KV]	2.5	2.5	2.5
Conductor cross section [mm ²]	0.2-1.5		

Material

Insulation Material	PA66
Flame retardant rating	UL94V-0
Conductor Material	Copper alloy
Plating of conductor surface	Sn plated

Other Date

Pitch/Poles [mm]/[P]	3.5/2-24
Stripping Length [mm]	7-8
Screw/Torque(Max)[N.m]	-
Operating temperature [°C]	-40 ~ +105

Dimensions

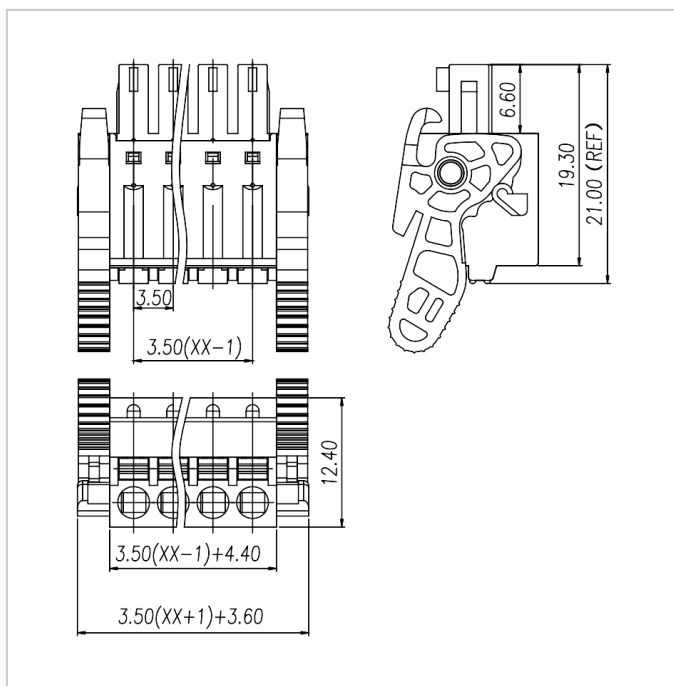

Accessories



WJ15EDGVMG-3.5



WJ15EDGRMG-3.5