

Rated current: 15A
 Rated voltage: 600V
 Use wire diameter: 28-12AWG
 spacing:10.0mm



The catalog is for reference only. The actual specifications are subject to the product engineering drawings. version 1.0

UL/CUL

Use Group	B	C	D
Rate Voltage [V]	600	-	600
Rated Current [A]	15	-	5
Wire Range [AWG]	28-12		
Dielectric Voltage-Withstand	2.2KV		

IEC

Overvoltage Category	III	III	II
Contamination Class	3	2	2
Rated Voltage [V]	630	1000	1000
Rated Current [A]	15	15	15

Impulse withstand voltage [KV]	8	8	8
Conductor cross section [mm ²]	0.2-2.5		

Material

Insulation Material	PA66
Flame retardant rating	UL94V-0
Conductor Material	Copper alloy
Plating of conductor surface	Sn plated

Other Date

Pitch/Poles [mm]/[P]	10.0/2-12
Stripping Length [mm]	7-8
Screw/Torque(Max)[N.m]	M3/0.5
Operating temperature [°C]	-40 ~ +105

Dimensions

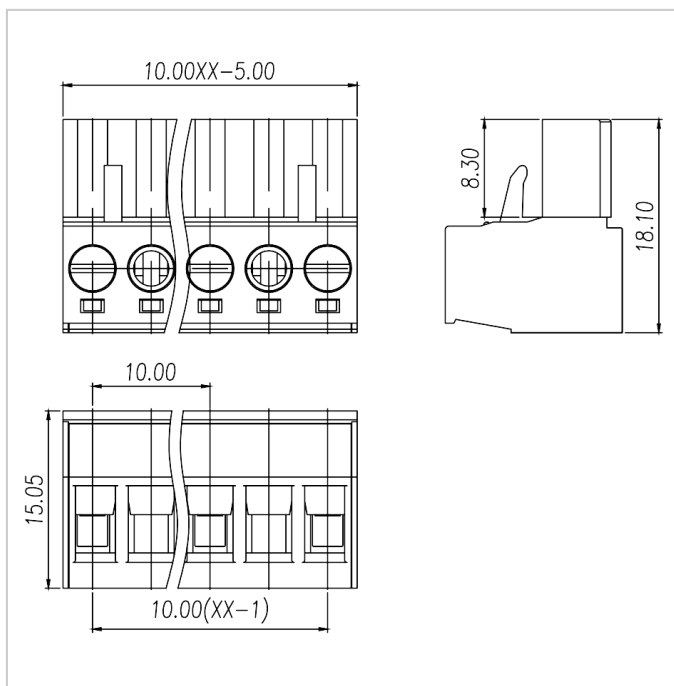

Accessories



WJ2EDGV-10.0



WJ2EDGR-10.0



WJ2EDGVC-10.0



WJ2EDGRC-10.0

Matching components

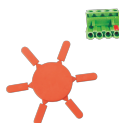

WJ2EDG-PWI