

Rated current: 10A

Rated voltage: 300V

Use wire diameter: 28-12AWG

spacing:5.08mm



The catalog is for reference only. The actual specifications are subject to the product engineering drawings. version 1.0

技术数据-UL/CUL

等级 Use Group	B	C	D
额定电压 Rate Voltage [V]	300	-	300
额定电流 Rated Current [A]	10	-	10
接线范围 Wire Range [AWG]	28-12		
耐电压 Dielectric Voltage-Withstand	1.6KV		

技术参数-IEC

过电压类别 Overvoltage Category	III	III	II
污染等级 Contamination Class	3	2	2
额定电压 Rated Voltage [V]	250	320	630
额定电流 Rated Current [A]	12	12	12

额定冲击电压 Impulse withstand voltage [KV]	4	4	4
导线截面积[硬/柔] Conductor cross section [mm ²]	0.2-2.5		

材料 Material

绝缘材料 Insulation Material	PA66
阻燃等级 Flame retardant rating	UL94V-0
导体材料 Conductor Material	Copper alloy
导体表面镀层 Plating of conductor surface	Sn plated

一般参数 Other Date

间距/极数 Pitch/Poles [mm]/[P]	5.08/2-24
剥线长度 Stripping Length [mm]	9-10
螺丝/扭矩 Screw/Torque(Max)[N.m]	-
工作温度 Operating temperature [°C]	-40 ~ +105

Dimensions

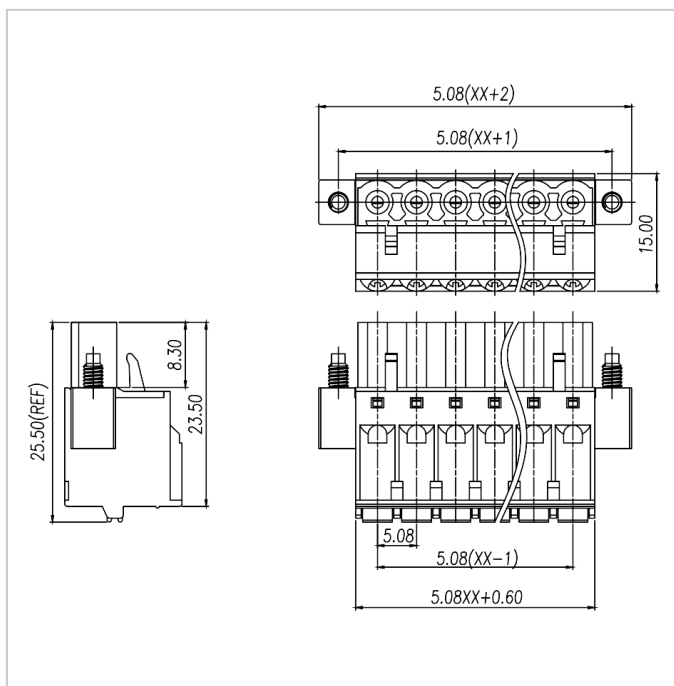

Accessories

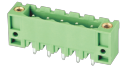

WJ2EDGVM-5.08



WJ2EDGRM-5.08

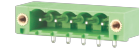

WJ2EDGRRM-5.08



WJ2EDGVM-THT-5.08



WJ2EDGRM-THT-5.08



WJ2EDGVTM-5.08



WJ2EDGRM-5.08



WJ2EDGVHM-5.08

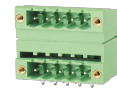

WJ2EDGRHM-5.08



WJ2EDGLM-5.08



WJ2EDGKRN-5.08

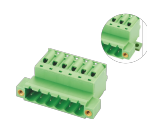

WJ2EDGKDRN-5.08

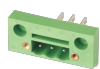

WJ2CDGM-5.08

Matching components

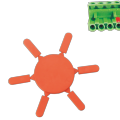

WJ2EDG-PWI