

Rated current: 41A
Rated voltage: 150V
spacing:7.62mm



The catalog is for reference only. The actual specifications are subject to the product engineering drawings. version 1.0

UL/CUL

Use Group	B	C	D
Rate Voltage [V]	300	300	300
Rated Current [A]	41	41	10
Wire Range [AWG]		-	
Dielectric Voltage-Withstand		1.6KV	

IEC

Overvoltage Category	III	III	II
Contamination Class	3	2	2
Rated Voltage [V]	630	630	1000
Rated Current [A]	41	41	41

Impulse withstand voltage [KV]	6	6	6
Conductor cross section [mm ²]	-		

Material

Insulation Material	PA66
Flame retardant rating	UL94V-0
Conductor Material	Copper alloy
Plating of conductor surface	Sn plated

Other Data

Pitch/Poles [mm]/[P]	7.62/2-12
Stripping Length [mm]	-
Screw/Torque(Max)[N.m]	-
Operating temperature [°C]	-40 ~ +105
Soldering method	Wave soldering
Pin dimensions [mm]	0.8*1.0
PCB Hole Diameter [mm]	Ø1.6

Dimensions

PCB hole diagram

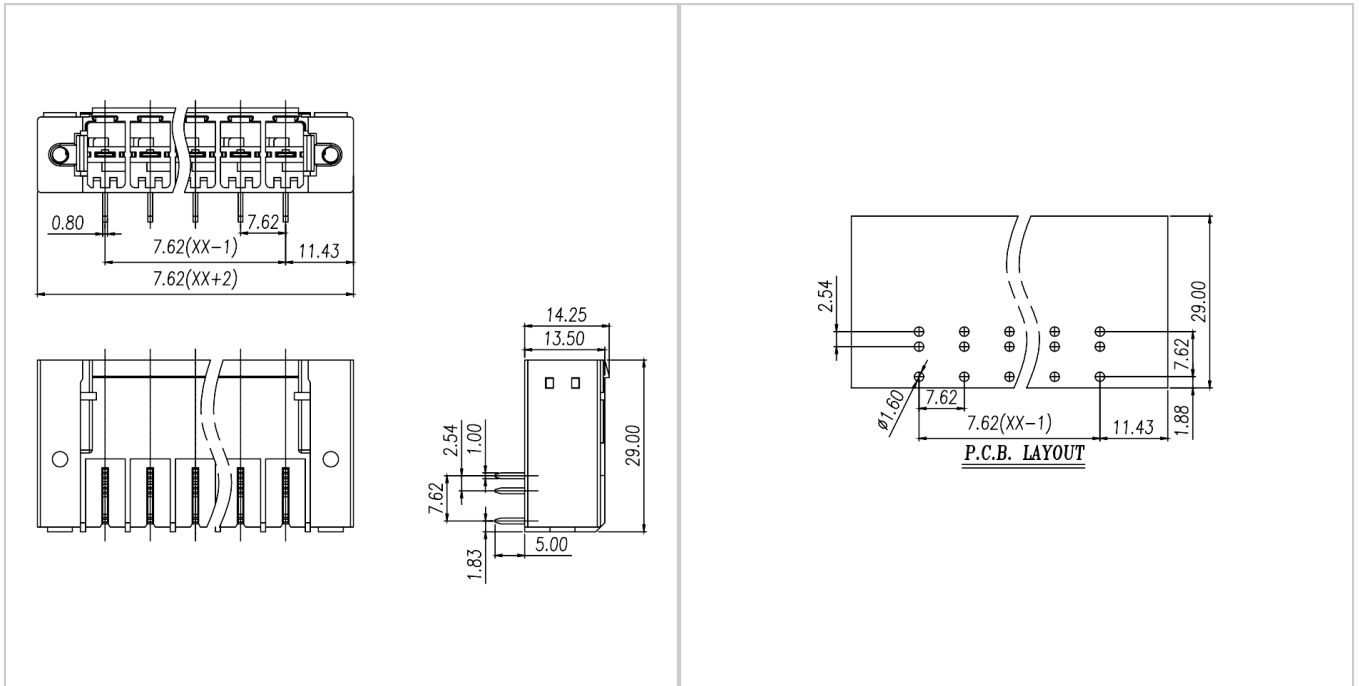

Accessories



WJ3EDGKM-7.62



WJ3EDGKVM-7.62



WJ3EDGKHM-7.62