

额定电流: 65A

额定电压: 600V

使用线径: 20-6AWG

目录仅供参考，实际规格依产品工程图为准 版本1.0

### 技术数据-UL ( 1059 )

| 等级 Use Group           | B    | C   | D   |
|------------------------|------|-----|-----|
| 额定电压 Rate Voltage [V]  | 600  | 600 | 600 |
| 额定电流 Rated Current [A] | 65   | 65  | 5   |
| 接线范围 Wire Range [AWG]  | 20-6 |     |     |

### 技术参数-IEC ( 60947-7-1 )

|   |          |
|---|----------|
| 额定电压 Rated Voltage [V]                            | 1000     |
| 额定电流 Rated Current [A]                            | 57       |
| 单芯 Solid [mm <sup>2</sup> ]                       | 0.5-16.0 |
| 柔性导线 Flexible [mm <sup>2</sup> ]                  | 0.5-10.0 |
| 柔性导线带冷压头 Flexible with ferrule [mm <sup>2</sup> ] | 0.5-10.0 |
| 过电压类别 Overvoltage Category                        | III      |

|                                       |   |
|---------------------------------------|---|
| 污染等级 Contamination Class              | 3 |
| 额定冲击电压 Impulse withstand voltage [KV] | 8 |

### 材料 Material

|                                     |              |
|-------------------------------------|--------------|
| 绝缘材料 Insulation Material            | PA66         |
| 阻燃等级 Flame retardant rating         | UL94V-0      |
| 导体材料 Conductor Material             | Copper alloy |
| 导体表面镀层 Plating of conductor surface | Sn plated    |

### 一般参数 Other Date

|                                    |                |
|------------------------------------|----------------|
| 长/高/厚 Length/Height/Thickness [mm] | 43.3/42.0/10.2 |
| 剥线长度 Stripping Length [mm]         | 10-11          |
| 螺丝/扭矩 Screw/Torque [N.m]           | M4/1.2-1.5     |

### 尺寸图

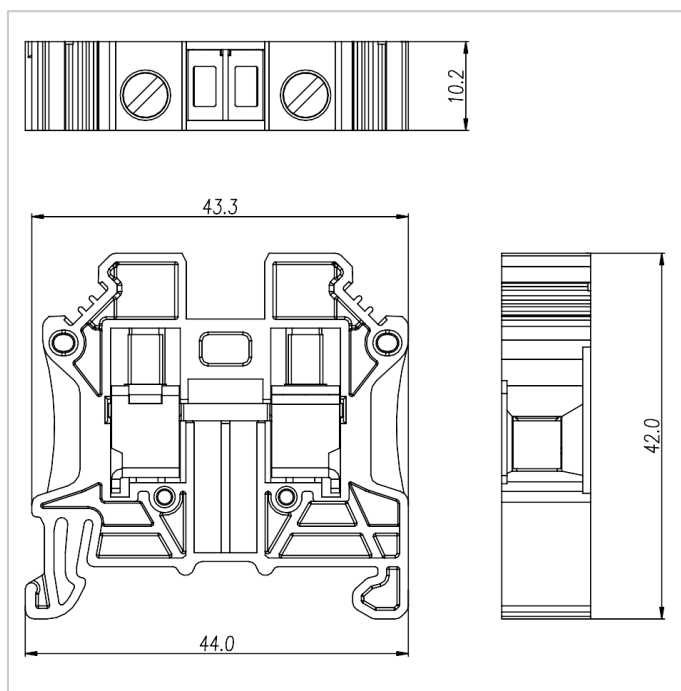

### 适配产品

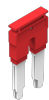

FUVA10-XX



DUT10-102

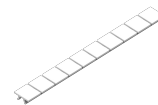

MUV10-10

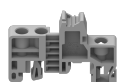

EB-35

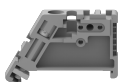

EW-35



EC-35



DGL2-35x7.5A

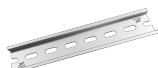

DGL2-35x7.5B

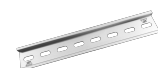

DGL2-35x7.5C



DGL2-35x7.5D