

M8 母头面板式，PCB型，前锁安装

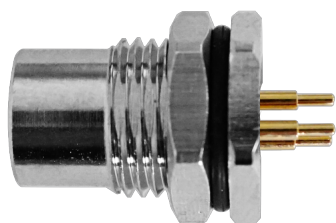

目录仅供参考，实际规格依产品工程图为准 版本1.0

## 连接器系列 Connector Series: M8

类型 Gender	Female 母
编码 Coding	A , B
装配方式 Locking Type	Fix Screw 锁螺丝
安装类型 Mounting Type	Front Fastened 前锁
产品编码 Part No	M08-X**-ST0-F01-BQ4

## 技术参数 Technical Data

标准 Standard	IEC61076-2-104
工作温度 Ambient Temperatur	-25°C~+85°C
绝缘电阻 Insulation Resistance	≥100MΩ
接触电阻 Contact Resistance	≤5mΩ
防护等级 IP Class	IP67

机械寿命 Mating Endurance	>100 Mating Cycles
-----------------------	--------------------

材质说明 Material Data

胶芯材料 Connector Carriers	PA
接触端子 Connector Contacts	Copper Alloy With Gold Plated 铜镀金
螺母/螺丝 Connector Nut/Screw	Copper Alloy With Nickel Plated 铜镀镍
屏蔽 Shielding	Unshielded 非屏蔽
密封胶圈 Seal/O-Ring	FKM 氟橡胶

电气参数&机械参数 Electrical Data & Mechanical Date

Pin数 Contacts Pin [Pins]	3	4	5	6	8
额定电流 Rated Current [A]	3	3	3	1.5	1.5
电压 Voltage AC/DC [V]	50/60	50/60	30/30	30/30	30/30
连接方式 Contacts Termination	PCB Version				

尺寸图

PCB开孔图

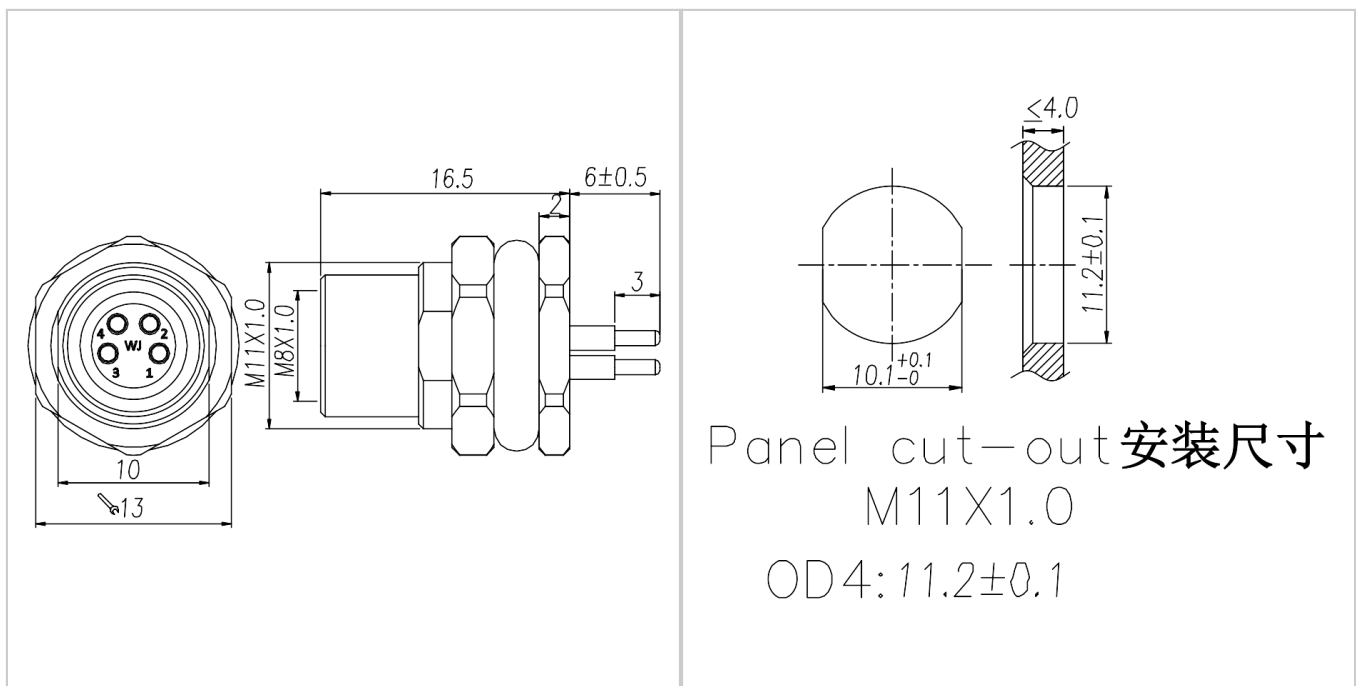

Panel cut-out 安装尺寸  
M11X1.0  
OD4: 11.2±0.1