

额定电流: 15A
 额定电压: 300V
 使用线径: 28-12AWG
 间距:7.62mm



目录仅供参考，实际规格依产品工程图为准 版本1.0

技术数据-UL/CUL

等级 Use Group	B	C	D
额定电压 Rate Voltage [V]	300	-	300
额定电流 Rated Current [A]	15	-	10
接线范围 Wire Range [AWG]	28 ~ 12		
耐电压 Dielectric Voltage-Withstand	1.6KV		

技术参数-IEC

过电压类别 Overvoltage Category	III	III	II
污染等级 Contamination Class	3	2	2
额定电压 Rated Voltage [V]	320	320	630
额定电流 Rated Current [A]	16	16	16
额定冲击电压 Impulse withstand voltage [KV]	6	6	6

导线截面积[硬/柔] Conductor cross section [mm²]

0.25-2.5

材料 Material

绝缘材料 Insulation Material

PA66

阻燃等级 Flame retardant rating

UL94V-0

导体材料 Conductor Material

Copper alloy

导体表面镀层 Plating of conductor surface

Sn plated

一般参数 Other Date

间距/极数 Pitch/Poles [mm]/[P]

7.62/2-24

剥线长度 Stripping Length [mm]

8-9

螺丝/扭矩 Screw/Torque(Max)[N.m]

-

工作温度 Operating temperature [°C]

-40 ~ +105

尺寸图

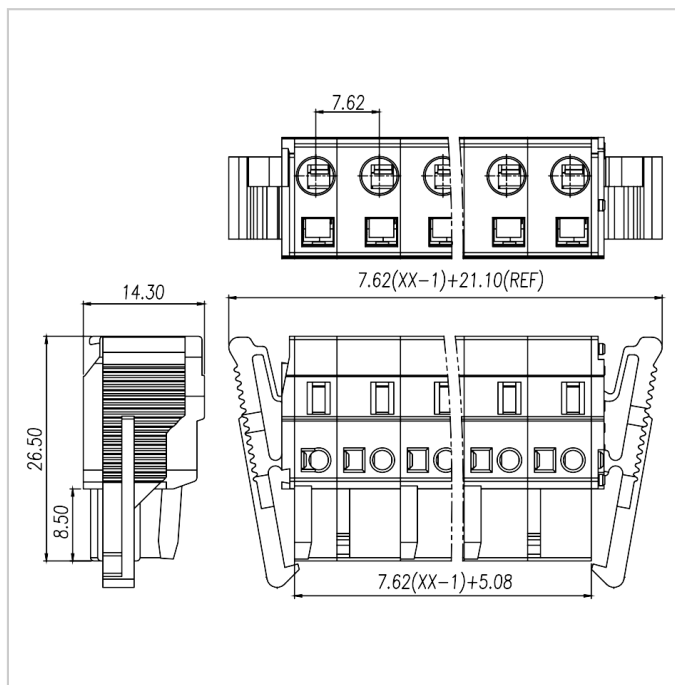

适配产品



WJ0702-05XX



WJ0702-06XX



WJ0702-07XX



WJ0702-08XX



WJ0703-04XX



WJ0703-05XX



WJ0703-06XX