



额定电流: 15A

额定电压: 300V

间距:7.5mm



目录仅供参考，实际规格依产品工程图为准 版本1.0

### 技术数据-UL/CUL

等级 Use Group	B	C	D
额定电压 Rate Voltage [V]	300	-	300
额定电流 Rated Current [A]	15	-	10
接线范围 Wire Range [AWG]	-		
耐电压 Dielectric Voltage-Withstand	1.6KV		

### 技术参数-IEC

过电压类别 Overvoltage Category	III	III	II
污染等级 Contamination Class	3	2	2
额定电压 Rated Voltage [V]	250	320	630
额定电流 Rated Current [A]	16	16	16
额定冲击电压 Impulse withstand voltage [KV]	6	6	6

导线截面积[硬/柔] Conductor cross section [mm <sup>2</sup> ]	-
<b>材料 Material</b>	
绝缘材料 Insulation Material	PA66
阻燃等级 Flame retardant rating	UL94V-0
导体材料 Conductor Material	Copper alloy
导体表面镀层 Plating of conductor surface	Sn plated
<b>一般参数 Other Data</b>	
间距/极数 Pitch/Poles [mm]/[P]	7.5/2-24
剥线长度 Stripping Length [mm]	-
螺丝/扭矩 Screw/Torque(Max)[N.m]	-
工作温度 Operating temperature [°C]	-40 ~ +105
焊接方式 Soldering method	Wave soldering
引针尺寸 Pin dimensions [mm]	1.2*1.2
PCB板孔径 PCB Hole Diameter [mm]	Ø2.0

尺寸图

PCB开孔图

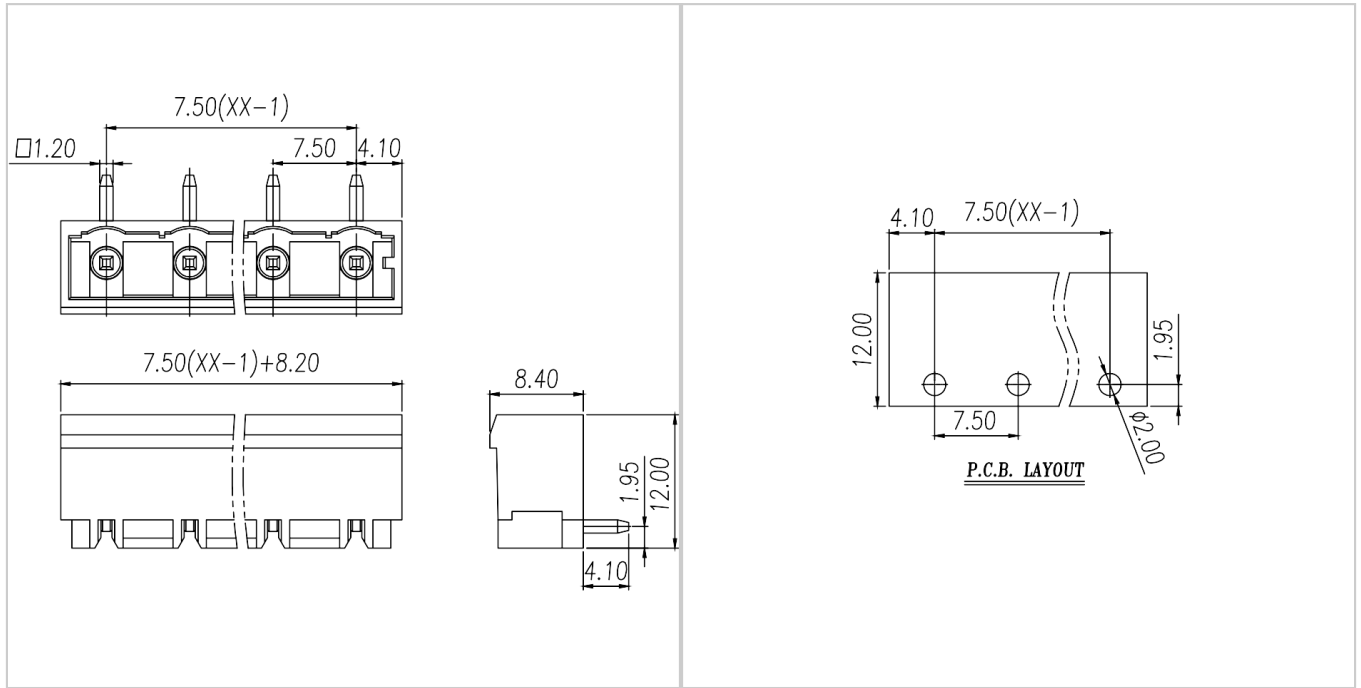

适配产品



WJ0601-01XX



WJ0601-03XX



WJ0601-05XX



WJ0601-07XX



WJ0605-01XX



WJ0605-03XX