

额定电流: 15A

额定电压: 300V

使用线径: 28-12AWG

间距:7.62mm



目录仅供参考，实际规格依产品工程图为准 版本1.0

技术数据-UL/CUL

等级 Use Group	B	C	D
额定电压 Rate Voltage [V]	300	-	300
额定电流 Rated Current [A]	15	-	10
接线范围 Wire Range [AWG]	28-12		
耐电压 Dielectric Voltage-Withstand	1.6KV		

技术参数-IEC

过电压类别 Overvoltage Category	III	III	II
污染等级 Contamination Class	3	2	2
额定电压 Rated Voltage [V]	320	320	630
额定电流 Rated Current [A]	12	12	12
额定冲击电压 Impulse withstand voltage [KV]	4	4	4

导线截面积[硬/柔] Conductor cross section [mm ²]	0.25-2.5
材料 Material	
绝缘材料 Insulation Material	PA66
阻燃等级 Flame retardant rating	UL94V-0
导体材料 Conductor Material	Copper alloy
导体表面镀层 Plating of conductor surface	Sn plated
一般参数 Other Date	
间距/极数 Pitch/Poles [mm]/[P]	7.62/2-24
剥线长度 Stripping Length [mm]	8-9
螺丝/扭矩 Screw/Torque(Max)[N.m]	-
工作温度 Operating temperature [°C]	-40 ~ +105

尺寸图

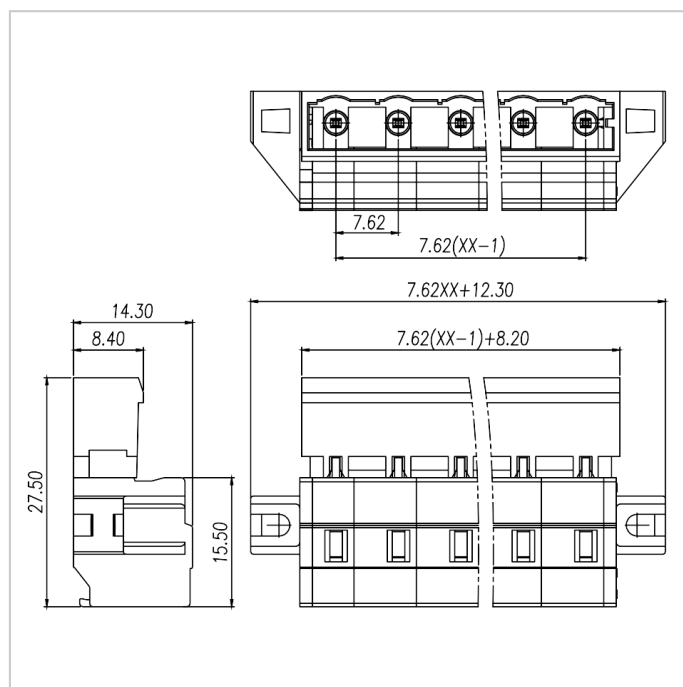

适配产品



WJ0701-01XX



WJ0701-03XX



WJ0701-05XX



WJ0701-07XX



WJ0705-01XX



WJ0705-03XX